



Canister Vac Owner's Guide SC3680-SC3699 Series Commercial Type



INDEX

Important Safeguards	2
Service Information	6
Use	7
Accessories	8
Maintaining	9
Dust Bag	9-10
Problem Solving	11
Warranty	14-15



www.southeasternequipment.net

1-800-440-6723

IMPORTANT SAFEGUARDS

When using an electric appliance, basic precautions should always be followed, including the following:

READ ALL INSTRUCTIONS BEFORE USING THIS VACUUM CLEANER.

WARNING

To reduce the risk of fire, electric shock, or injury:

- Do not use outdoors or on wet surfaces.
- This appliance is provided with double insulation. Use only identical replacement parts. See instructions for Servicing of Double-Insulated Appliances.
- **Do not leave vacuum cleaner when plugged in.** Turn off the switch and unplug the electrical cord when not in use and before servicing.
- Do not allow to be used as a toy. Close attention is necessary when used by or near children.
- Use only as described in this manual. Use only manufacturer's recommended attachments.
- Do not use with damaged cord or plug. If vacuum cleaner is not working as it should, has been dropped, damaged, left outdoors, or dropped into water, return it to a service center before using.
- Do not pull or carry by cord, use cord as a handle, close a door on cord, or pull cord around sharp edges or corners. Do not run vacuum cleaner over cord. Keep cord away from heated surfaces.
- Do not use extension cords or outlets with inadequate current carrying capacity.
- Turn off all controls before unplugging.
- Do not unplug by pulling on cord. To unplug, grasp the plug, not the cord.
- Do not handle plug or vacuum cleaner with wet hands or operate without shoes.
- Do not put any object into openings. Do not use with any opening blocked; keep free of dust, lint, hair, and anything that may reduce airflow.
- This vacuum cleaner creates suction. Keep hair, loose clothing, fingers, and all parts of body away from openings and moving parts.
- Do not pick up anything that is burning or smoking, such as cigarettes, matches, or hot ashes.
- Do not use without dust bag or filter(s) in place.
- Use extra care when cleaning on stairs.
- Do not pick up flammable or combustible liquids such as gasoline, or use in areas where they may be present.
- Store your cleaner indoors in a cool, dry area.
- Keep your work area well lighted.
- Unplug electrical appliances before vacuuming them.

SAVE THESE INSTRUCTIONS

CONSEILS DE SÉCURITÉ

Lors de l'utilisation d'un appareil électrique, quelques précautions élémentaires doivent être observées, incluant les suivantes:

LISEZ TOUTES LES INSTRUCTIONS AVANT D'UTILISER VOTRE ASPIRATEUR.

AVERTISSEMENT

Pour réduire le risque de feu, de choc électrique ou de blessure:

- Ne pas utiliser l'aspirateur à l'extérieur ou sur une surface mouillée.
- Cet appareil est muni d'un double-isolément. Utilisez uniquement des pièces de rechange identiques. Voir les instructions pour l'entretien d'appareils à double-isolément.
- **Ne pas laisser l'aspirateur seul quand il est branché.** Mettre l'interrupteur sur arrêt et débrancher l'appareil lorsque vous ne l'utilisez pas ou avant l'entretien.
- Ne pas permettre que l'aspirateur soit utilisé comme un jouet. Une attention particulière est nécessaire lorsqu'il est utilisé par ou près d'un enfant.
- Suivre strictement les recommandations d'utilisation de ce manuel. Utiliser uniquement les accessoires recommandés par le fabricant.
- Ne jamais utiliser l'aspirateur si le cordon ou la fiche sont endommagés. Si l'aspirateur ne fonctionne pas comme il le devrait, s'il a été échappé, s'il est endommagé, s'il a été laissé à l'extérieur ou échappé dans de l'eau, le retourner à un centre de service avant de l'utiliser.
- Ne pas l'aspirateur ou le transporter par le cordon. Ne pas utiliser le cordon en guise de poignée. Ne pas fermer une porte sur le cordon ou tirer le cordon sur des bordures ou des coins pointus. Ne pas passer l'aspirateur sur le cordon. Tenir le cordon à distance des surfaces chauffantes.
- Ne pas utiliser des cordons de rallonge ou des prises qui n'ont pas une capacité suffisante pour transporter le courant.
- Mettre sur arrêt tous les boutons de commande avant de débrancher.
- Ne pas débrancher l'aspirateur en tirant sur le cordon. Pour débrancher saisir la fiche et non pas le cordon.
- Ne pas manipuler la fiche ou l'aspirateur les mains mouillées ou faire fonctionner pieds nus.
- Ne rien insérer dans les ouvertures. Ne pas utiliser l'aspirateur si des ouvertures sont bloquées. Vous assurer qu'elles soient dégagées de poussière, de mousse, de cheveux ou de tout autre chose qui pourrait réduire le passage de l'air.
- Cet aspirateur crée de la suction. Tenir les parties mobiles et les ouvertures loin des cheveux, du linge, des doigts et de toute partie du corps.
- Ne pas ramasser des objets qui brûlent ou fument comme les cigarettes, les allumettes ou les cendres chaudes.
- Ne pas utiliser sans que le sac à poussière ou le(s) filtre(s) ne soient en place.
- Porter une attention particulière lorsque vous nettoyez les escaliers.
- Ne pas utiliser pour ramasser des liquides inflammables ou combustibles, comme de l'essence. Ne pas utiliser dans les endroits où ces liquides pourraient être présents.
- Entreposer votre aspirateur à l'intérieur, dans un endroit propre et sec.
- Maintenir un bon éclairage à l'endroit où vous travaillez.
- Débrancher les appareils électriques avant de les passer à l'aspirateur.

CONSERVEZ CES INSTRUCTIONS

Servicing of Double-Insulated Appliances

A double-insulated appliance is marked with one or more of the following: The words “DOUBLE INSULATION” or “DOUBLE INSULATED” or the double insulation symbol (square within a square).

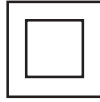

In a double-insulated appliance, two systems of insulation are provided instead of grounding. No grounding means is provided on a double-insulated appliance, nor should a means for grounding be added to the appliance. Servicing a double-insulated appliance requires extreme care and knowledge of the system, and should be done only by qualified service personnel. Replacement parts for a double-insulated appliance must be identical to the parts they replace.

To reduce the risk of electric shock, this appliance has a polarized plug (one blade wider than the other). This plug will fit in a polarized outlet only one way. If the plug does not fit fully in the outlet, reverse the plug. If it still does not fit, contact a qualified electrician to install the proper outlet. Do not change the plug in any way.

Afin de réduire le risque de choc électrique, cet appareil est muni d'une fiche polarisée (une des lames est plus large). Cette fiche ne peut être insérée dans une prise polarisée que d'une seule façon. Si la fiche ne peut être insérée dans la prise, retourner la fiche. Si la fiche ne peut toujours pas être insérée dans la prise, faire installer une prise adéquate par un électricien qualifié. Ne pas modifier la fiche.

GENERAL INFORMATION

The cleaner is designed to pick up dirt and dust particles. Avoid picking up hard or sharp objects with the cleaner to avoid bag breakage, hose clogging, or possible motor damage.

Service Information

The instructions in this booklet serve as a guide to routine maintenance. For additional service information telephone our toll free number for the nearest Eureka Authorized Warranty Station. **You should know the model, type and serial numbers when you call:**

USA: 1-800-282-2886

Mexico: 5670-6169

Canada: 1-800-282-2886

If you prefer, you can write to The Eureka Company, Service Division, 807 North Main Street, Bloomington, Illinois 61701, USA. In Canada write to The Eureka Company, 866 Langs Drive, Cambridge, Ontario N3H 2N7. Refer to The Eureka Warranty for complete service information.



DO NOT OIL the motor at any time. The bearings are permanently lubricated and sealed.

Rating Plate

The model, type, and serial numbers are indicated on the rating plate located on the back side of the cleaner. For prompt and complete service information, always refer to these numbers when inquiring about service.

MODEL	TYPE	SERIAL NO.
VOLTS	AMPS.	HERTZ
SERVICE INFORMATION: 1-800-282-2886		
 THE EUREKA COMPANY BLOOMINGTON, ILLINOIS 61701		

Model & Type _____

Serial No. _____

Automatic Motor Shut-Off

To protect from overheating, this vacuum cleaner is equipped with a thermostat which automatically shuts off the motor if it overheats. Should this happen:

1. **Turn off the switch and unplug the cleaner** because the thermostat will allow the cleaner to automatically start running again when the motor cools (approximately 30 minutes).
2. **Check the hose, bag and filter** regularly, as a clogged hose, full bag or dirty filter could cause the motor to overheat.
3. **Call a Eureka Service Station** if the cleaner will not operate after cooling for approximately 30 minutes.

HOW TO USE

CAUTION: Moving parts. Make sure on/off switch is in off position before plugging in.

A carpet should be cleaned regularly over heavily traveled areas, and once a week over the entire carpeted area. Vacuum slowly, making several passes (forward and backward) over the carpet, covering small areas at a time. The time required to clean the carpet will depend on several factors—including type of carpet and amount of dirt.

1 Connect Hose

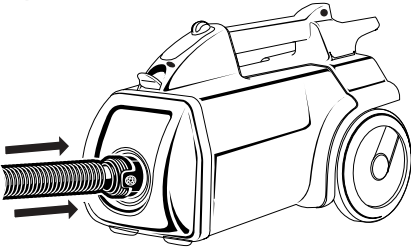

2 Rotate Swivel Hook to release cord

3 Plug In

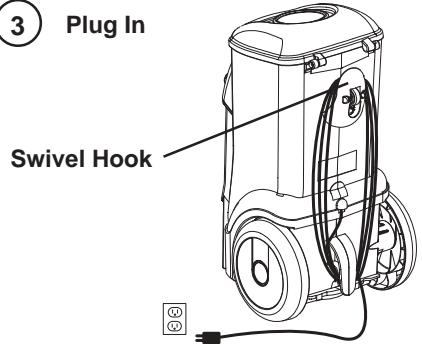

4 Store Tools

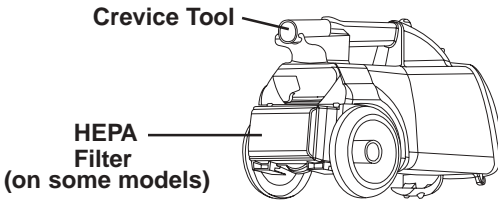

5 Attach Carrying Strap (on some models)

The carrying strap has two safety pin type closures at each end. Fasten each one into the holes shown below on the cleaner.

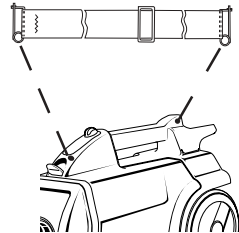

6 Push ON/OFF Switch

(A thermostat automatically shuts the motor off if it overheats, see Automatic Motor Shut-Off)

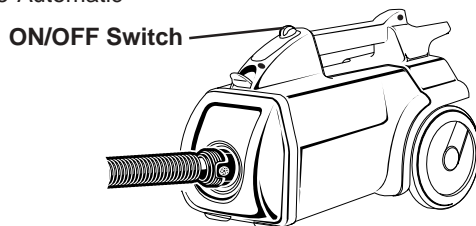

Cleaning Accessories

Attach wands and cleaning tools

(Wands may vary by model)

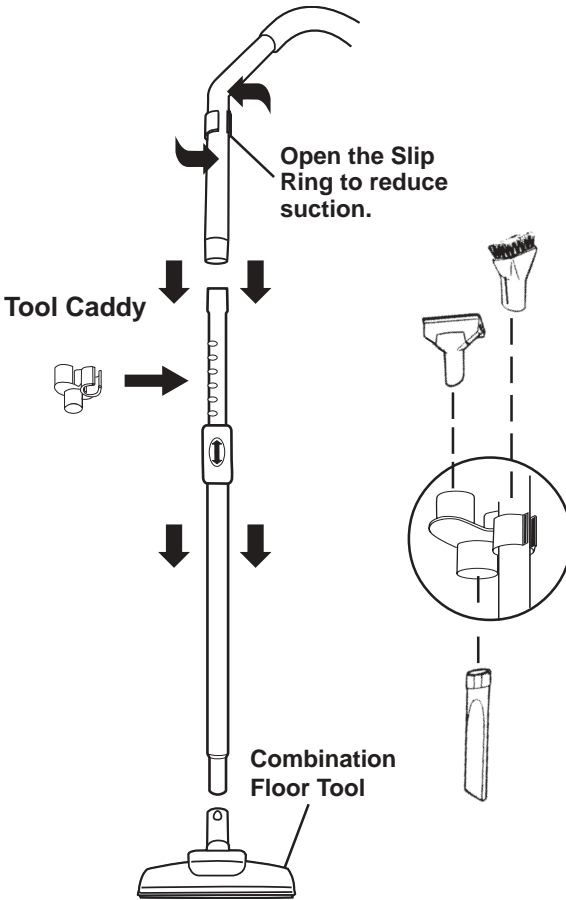

Telescoping Wand

To adjust the length of the telescoping wand, hold the wand adjustment collar in one hand while pulling or pushing the wand with the other hand until you have the desired length.

Wand Adjustment Collar



Slip the circular end of an accessory tool onto the end of the hose handle and twist slightly to secure. If additional reach is needed, place a wand on the hose handle first.

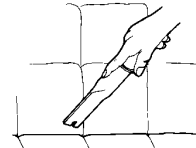

Crevice Tool

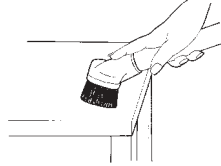

Upholstery Nozzle

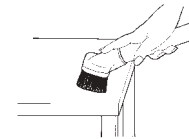

Dusting Brush



***Bare Floor Brush (optional)**

Crevice Tool: For crevices, corners, baseboards, between cushions.

Upholstery Nozzle: For curtains, draperies, cushions, fabrics.

Dusting Brush: For furniture, blinds, books, lamp shades, shelves.

Bare Floor Brush: For any type of hard surface floor.

*May be purchased separately.

HOW TO MAINTAIN

The instructions given in this booklet serve as a guide to routine maintenance. To avoid unnecessary service calls, check the hose, bag and filter often. Clear a clogged hose with the blower, change the bag if it is full, and clean the motor filter when it is dirty.

Disposable Dust Bags and Filters

The dust bag and motor filter play a very important roll in the efficiency of the vacuum cleaner. The purpose of the dust bag is to trap dirt, but at the same time, the paper bag must be porous enough to allow air to pass through. If the bag or the motor filter become clogged, no air can pass through the cleaner and no cleaning can take place regardless of how powerful the unit is. To keep the cleaner operating at maximum efficiency, change the dust bag frequently and clean the filter as needed. Some fine particles can restrict airflow very quickly and will decrease performance even before the bag appears to be full. For that reason, when vacuuming carpet fresheners or cleaners, powder, plaster dust, or similar fine substances, the bag and filter may need to be changed more often.

Look for the **GENUINE** symbol.
EUREKA PRODUCT

FILTERAIRE® Disposable Dust Bag (optional)

Our high filtration bag is a two-layer, disposable bag that combines our standard paper bag with a nonwoven air filter inside. Use a Filteraire dust bag to create a cleaner indoor environment because the bag filters better than our standard bag. The bags are available (three in a package) from your local dealer, or you can call 1-800-282-2886 for other locations. Look for the Genuine Eureka Filteraire dust bag—Style MM.

How to Remove Disposable Dust Bags—Style MM

NOTE: Turn off vacuum and unplug the electrical cord before changing dust bag or cleaning motor filter. Never operate the vacuum cleaner without the dust bag or filter.

- 1 Turn off and unplug cleaner.
- 2 Open lid by pushing down hood latch.
- 3 Fold BAG CLOSURE FLAP down and push behind rubber seal.
- 4 Insert finger into upper left notch then pull out and remove bag.

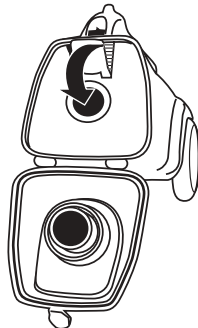
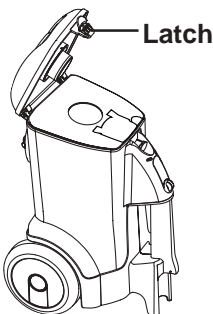

How to Install Disposable Dust Bags—Style MM

NOTE: Turn off vacuum and unplug the electrical cord before changing dust bag or cleaning motor filter. Never operate the vacuum cleaner without the dust bag or filter.

1. Turn off and unplug cleaner.
2. Open bag cover by pushing latch.
3. Clean motor filter by rinsing under warm water and let air dry if heavily soiled.

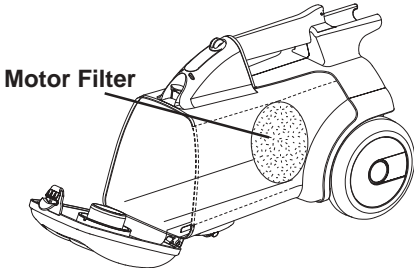
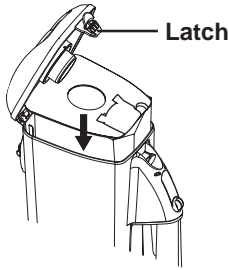

4. Open bag folds slightly.
5. Place bag in cleaner.
6. Tuck bag corners under collar.
7. Swing bag cover closed and push to latch.

How to Install HEPA Filter (on some models)

Check the HEPA filter with each disposable dust bag change. Replace twice a year or after every six bag changes.

Upper Filter Tabs

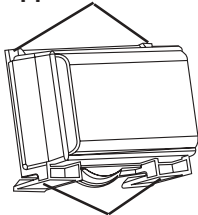

Bottom Clips

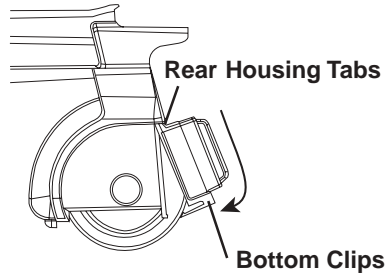

Insert upper filter corner tabs firmly under rear housing tabs and pivot filter down until bottom clips on filter click securely into place on the cleaner.

How to Remove HEPA Filter

Grasp the bottom clips on the filter and pull out and down to release the upper filter tabs from the rear housing tabs on the cleaner.

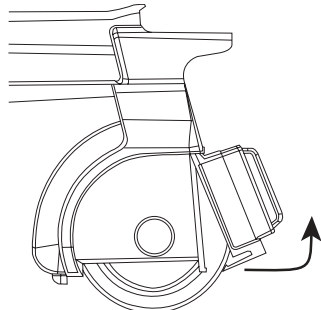

Replace with **GENUINE EUREKA PRODUCT** filter, part number 60666.

PROBLEM SOLVING

NOTE: Turn OFF the power switch and unplug the electrical cord before servicing.

PROBLEM	CAUSE	SOLUTION
Motor won't start	<input checked="" type="checkbox"/> Electric plug <input checked="" type="checkbox"/> Power switch not turned "ON"	<input type="checkbox"/> Push plug securely into outlet. <input type="checkbox"/> Try another outlet. <input type="checkbox"/> Check circuit breaker. <input type="checkbox"/> Make sure power switch is "ON."
No suction at end of hose	<input checked="" type="checkbox"/> Full paper bag <input checked="" type="checkbox"/> Hose <input checked="" type="checkbox"/> Front cover not latched	<input type="checkbox"/> Replace paper bag. <input type="checkbox"/> Remove any clogs from hose that restrict airflow, then try again. <input type="checkbox"/> Push front cover until it latches firmly.
Reduced suction	<input checked="" type="checkbox"/> Full paper bag <input checked="" type="checkbox"/> Slip ring open <input checked="" type="checkbox"/> Hose	<input type="checkbox"/> Replace paper bag. <input type="checkbox"/> Rotate slip ring on wand until hole is covered. <input type="checkbox"/> Remove any clogs from hose that restrict airflow, then try again.
Cleaner shuts off	<input checked="" type="checkbox"/> Internal safety thermostat trips <input checked="" type="checkbox"/> Cord connection at hose	<input type="checkbox"/> Unplug cleaner and check for obstructions in hose, wands and attachments. <input type="checkbox"/> Check for full paper bag. <input type="checkbox"/> Clean/replace motor filter. <input type="checkbox"/> Check powerhead and hose plugs for proper connection.
General questions	<input checked="" type="checkbox"/> Assembly or related attachments	<input type="checkbox"/> Call 1-800-282-2886 between 7:00 AM–8:00 PM central standard time, Monday through Saturday. Know the model number and serial number when you call.

THE SANITAIRE® COMMERCIAL LIMITED WARRANTY

WHAT THIS WARRANTY COVERS

Your Sanitaire commercial cleaner is warranted to be free from all defects in material and workmanship in normal use FOR A PERIOD OF ONE YEAR. The warranty is granted only to the original purchase of the cleaner. The warranty is subject to the following provisions.

WHAT THIS WARRANTY DOES NOT COVER

- Parts of the cleaner that require replacement under normal use, such as bumpers, bags, and hoses.
- Damages or malfunctions caused by negligence, abuse, or use not in accordance with the Owner's Guide.
- Defects or damages caused by unauthorized service or the use of other than Genuine Eureka parts.

WHAT THE EUREKA COMPANY WILL DO

The Eureka Company will, at its option, repair or replace a defective cleaner or cleaner part that is covered by this warranty. As a matter of warranty policy, the Eureka Company will not refund the consumer's purchase price.

WARRANTY REGISTRATION

Please fill out and return the warranty registration card accompanying your cleaner.

—continued on reverse side—

OBTAINING WARRANTY SERVICE

To obtain warranty service you must return the defective cleaner or cleaner part along with proof of purchase to any Eureka/Sanitaire Authorized Warranty Station. You will find the nearest location in the Yellow Pages under "Vacuum Cleaners—Service and Repair." Be certain that the Warranty Station is "Eureka/Sanitaire Authorized."

For the location of the nearest Eureka/Sanitaire Authorized Warranty Station or for service information, telephone toll free:

USA: 1-800-282-2886

Mexico: 5670-6169

Canada: 1-800-282-2886

If you prefer, you can write to:

The Eureka Company
Service Division
807 North Main Street
Bloomington, IL 61701, USA

In Canada write to:

The Eureka Company
866 Langs Drive
Cambridge, Ontario N3H 2N7

If it is necessary to ship the cleaner outside your community to obtain warranty repair, you must pay the shipping charges to the Eureka/Sanitaire Authorized Warranty Station. Return shipping charges will be paid by the Warranty Station. When returning parts for repair, please include the model, type, and serial numbers from the data plate on the cleaner.

FURTHER LIMITATIONS AND EXCLUSIONS

Any warranty that may be implied in connection with your purchase or use of the cleaner, including any warranty of MERCHANTABILITY or any warranty for FITNESS FOR A PARTICULAR PURPOSE is limited to the duration of this warranty. Some states do not allow limitations on how long an implied warranty lasts, so the above limitations may not apply to you.

Your relief for the breach of this warranty is limited to the relief expressly provided above. IN NO EVENT SHALL EUREKA BE LIABLE FOR ANY CONSEQUENTIAL OR INCIDENTAL DAMAGES THAT YOU MAY INCUR IN CONNECTION WITH YOUR PURCHASE OR USE OF THE CLEANER. Some states do not allow the exclusion or limitation of incidental or consequential damages, so the above limitation or exclusion may not apply to you.

This warranty gives you specific legal rights. You may also have other rights which vary by State.



www.southeasternequipment.net

 1-800-440-6723

