







M17

Battery Sweeper-Scrubber

An innovative, high-performance battery sweeper-scrubber focused on delivering customized solutions to meet customer needs. The M17 cleans effectively in just one pass, enhances indoor air quality, and improves operator and supervisor experience, all in one machine!

Available technologies

-  ec-H2O™ technology
-  Pro-Panel™ LCD Touch Screen or Touch-n-Go™ control module
-  IRIS® Asset Manager
-  ES® Extended Scrubbing
-  High capacity battery power sources

Engineered for **productivity**



1. Touch-n-Go™ control module with 1-Step™ start button allows operators quick access to settings without removing hands from the steering wheel. Also available with optional Pro-Panel™ technology.

2. Powered high dump eliminates the need to manually handle debris and enables you to place larger debris into the hopper for later disposal.

3. Recovery tank access step allows easy access to inspect and clean the recovery tank.

4. Revolutionary patent-pending water trap helps reduce spills and dripping by providing unrestricted airflow and captures moisture left in the recovery hose on shutdown.

5. Swinging squeegee provides excellent water recovery to help reduce the risk of slips and falls.

6. Large battery capacity options extend runtime for increased productivity.

Optional Accessories



Pressure washer delivers a powerful spray to clean tough soils.



FOPS certified overhead guard protects operators from falling objects.



Rear squeegee protection kit helps prevent squeegee damage.



Live vacuum wand for quickly picking up miscellaneous debris like shrink wrap.

Inside the M17

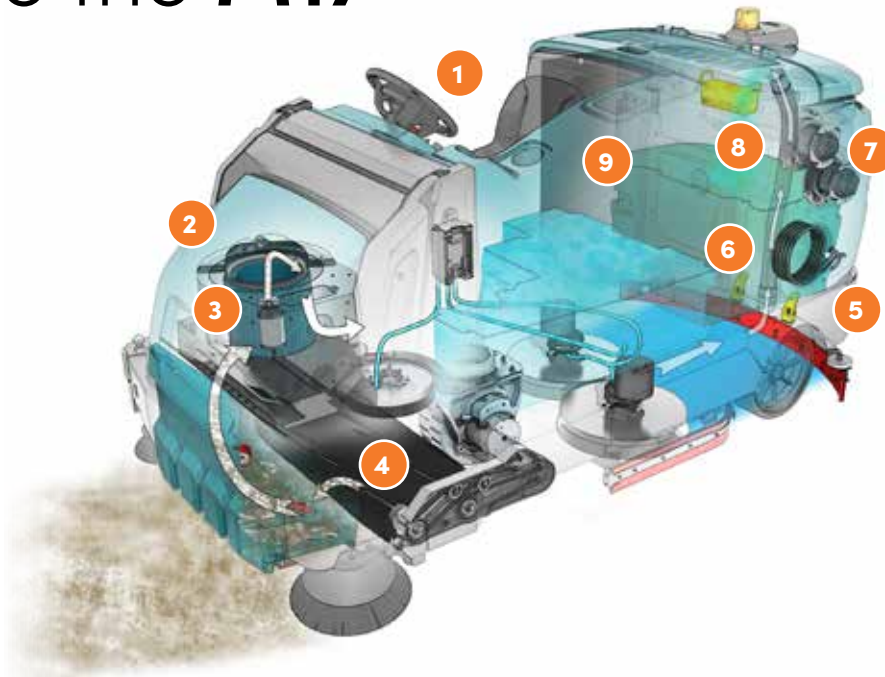

- 1. Forward operating position** improves operator safety and visibility.
- 2. Full front shroud** ensures operator leg and foot protection.
- 3. Two-stage dust control system** featuring the ShakeMax™ filter shaker maintains air quality by containing dust generated during the sweeping process.
- 4. DFS™ Dual Force Sweeping** technology easily captures larger, heavier debris as well as pallet chips less than 6" long with 2.5 ft³ hopper. Optional Direct Throw sweeping system picks up longer pallet chips and finer debris like dust and sand.
- 5. Wraparound steel bumper** helps protect your investment.
- 6. Yellow touch points** save time and ensure proper maintenance.
- 7. Dual vacuum fans** with corrosion-resistant impeller design for long life.
- 8. Debris basket** keeps material out of the recovery tank and prevents clogging.
- 9. Solution tank surroundings** are engineered to provide maximum visibility, expanding sightlines to the left-hand sweeping side brush.

Get the performance you need

The M17 sweeper-scrubber delivers consistent cleaning results in even the toughest environments with effective sweeping, scrubbing, and edge-cleaning capabilities.



Scrubbing side brush for increased edge reach and 20% wider path



Cylindrical scrub head for scrubbing on rough floor surfaces



Dual sweeping side brushes ensure entire scrub path is swept

M17 Specifications

CLEANING SYSTEM

Scrubbing Path (main scrub deck) With scrubbing side brush	40 in / 1,015 mm 48 in / 1,220 mm
Dual Force Sweeping Path (main sweeping system) With dual sweeping brushes	36 in / 915 mm 67 in / 1,700 mm
Direct Throw Sweeping Path (main sweeping system) With dual sweeping brushes	35 in / 889 mm 67 in / 1,700 mm
Cylindrical brush speed	500 rpm
Cylindrical brush down force (up to)	550 lb / 250 kg
Debris hopper	0.7 ft ³ / 20 L
Disk brush speed	315 rpm
Disk brush down force (up to)	550 lb / 250 kg
Solution tank	75 gal / 285 L
Solution capacity (ES®)	115 gal / 435 L
Recovery tank	91.1 gal / 346 L
Debris capacity maximum Usable Dual Force Usable Direct Throw	3.0 ft ³ / 85L 2.5 ft ³ / 70.8 L 1.07 ft ³ / 30.3 L

PROPELLING SYSTEM

Propel speed forward (transport variable to) Propel speed forward (scrubbing variable to)	5.5 mph / 8.9 km / h 4.0 mph / 6.5 km / h
Dual Force Gradeability - Working Transport Trailer Loading*	6° / 10.5% 7.5° / 13% 11.5° / 20%
Dual Throw Gradeability - Working Transport* Trailer Loading*	3° / 5% 7.5° / 13% 7.5° / 13%

*sweep hopper must be lifted prior to going on a 5° ramp

BATTERY SELECTIONS

Battery packages	Wet 750 AH C6
(Battery chargers available for all optional batteries)	Wet 930 AH C6

MACHINE SPECIFICATIONS

Length basic machine	112.8 in / 2,850 mm
Width, body	54 in / 1,370 mm
Height (top of steering wheel)	58.25 in / 1,480 mm
With overhead guard	82.5 in / 2,096 mm
Weight empty (no battery)	3,335 lb / 1,515 kg
Minimum aisle turn	118.25 in / 3,003 mm





WARRANTY

See your local representative for warranty information

Specifications subject to change without notice.

Tennant – Reinvent how the world cleans

With a vision to become a global leader in sustainable cleaning innovation that empowers our customers to create a cleaner, safer and healthier world, Tennant creates solutions that are changing the way the world cleans.

- 
We are where you are
 Tennant has the industry's largest direct sales and service organization and a well-supported network of authorized distributors worldwide.
- 
Solutions for your unique needs
 Whatever your cleaning needs, Tennant offers a variety of high quality equipment to help you increase your cleaning productivity.
- 
Buying, leasing, renting
 We offer flexible options to get you the machines you need, however you need them.
- 
TennantTrue®
 Optimize equipment performance and protect your investment with TennantTrue® parts and service.

For a demonstration or additional information, call **+1.800.553.8033** or email **info@tennantco.com**

Tennant Company
 10400 Clean Street
 Eden Prairie, MN 55344-2650, USA

USA/Canada: +1.800.553.8033
 Quebec: +1.800.361.9050
 Overseas: +1.763.540.1315

www.tennantco.com | info@tennantco.com